

Prima Manual

V.1.0

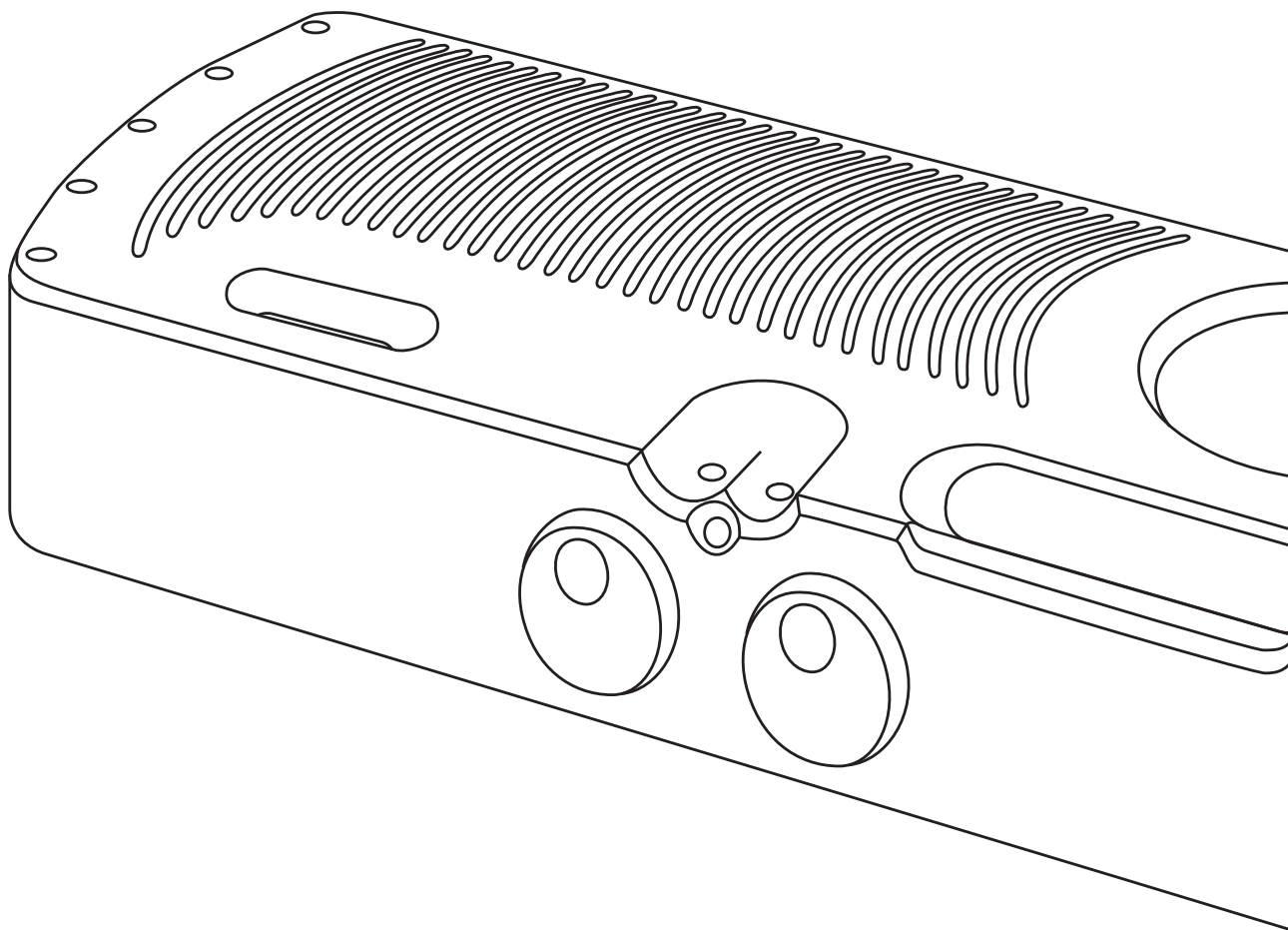

Chord Electronics Ltd.



Contents

0.0

| | | | |
|--|-----------|---|-----------|
| 1.0 Safety instructions | 03 | 2.0 Warranty | 08 |
| 1.1 Introduction | 04 | 2.1 Warranty period & registering your purchase | 09 |
| 1.2 Protection against liquids & heat | 05 | 2.2 Making a claim & warranty exclusions | 10 |
| 1.3 Dismantling & Radio frequency interference | 06 | | |
| 1.4 Connecting your equipment | 07 | | |
| | | | |
| 3.0 Getting to know PRIMA | 11 | 4.0 Setting up PRIMA | 16 |
| 3.1 Getting to know PRIMA | 12 | 4.1 Placement | 17 |
| 3.3 The top panel | 13 | 4.2 Connecting an input to Prima | 18 |
| 3.4 The rear panel | 14 | 4.3 Connecting Prima to a Power amplifier | 19 |
| 3.5 The remote control | 15 | 4.4 Connecting PRIMA to a recording device | 20 |
| | | | |
| 5.0 How to navigate the menu | 21 | 6.0 Special features | 26 |
| 5.1 Basic navigation | 22 | 6.1 Gain | 27 |
| 5.2 Volume and balance control | 23 | | |
| 5.3 Display | 24 | | |
| 5.4 Viewing settings | 25 | | |

0.0

Contents

Safety instructions

1.0

- 1.1 Introduction
- 1.2 Protection against liquids & heat
- 1.3 Dismantling & Radio Frequency interference
- 1.4 Connecting your equipment

1.0 *Safety instructions*

Introduction

1.1



PRIMA is a device that converts your sources to 705.6 or 768kHz 24-bit PCM and achieves reconstruction of the original analogue signal in the ADC to a better than 16-bit accuracy under all conditions.

Before operation, we strongly advise you read this user manual thoroughly.

We also recommend that you store this user manual, along with your original receipt of purchase, in a safe place should you require assistance in the future.

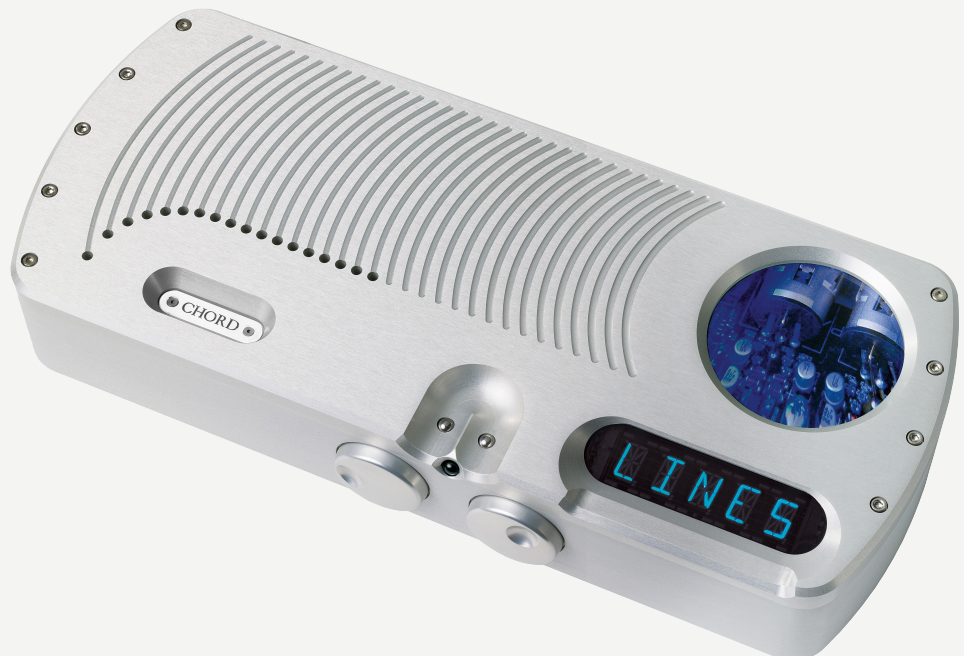

 *Made in* **BRITAIN**

Protection against liquids & heat

1.2



Prima is not protected against liquids of any kind. Never place containers of liquid on Prima. Never allow Prima to come into contact with moisture or liquids; doing so could result in electrocution or damage to the Prima's internal circuitry.

Be aware that liquids, including water that has dried, can leave minerals that can affect the PCB and other components, which could eventually lead to oxidation and short-circuiting.

If the Prima comes into contact with moisture or liquids, immediately disconnect from the mains power supply, and connected equipment and contact Chord Electronics for further advice.



The Prima has internal thermal protection which will shut down the unit in the event of excessive temperatures being reached. Never operate the Prima near sources of heat or naked flames as this will decrease the lifespan of the internal components. It is advised that you do not operate the Prima in an area of direct sunlight or on top of significant heat-producing devices.

Please be aware that it is entirely normal for the Prima to become warm during use, particularly within a stacked configuration. If you are concerned about the temperatures, please switch the device off or consider a different placement.

Dismantling & radio frequency interference

1.3



There are no user-serviceable components within the Prima or its power supply. Dangerous voltages/currents exist within the Prima and its power supply, posing a severe risk of electrocution and/or fire.



Never attempt to open, dismantle or apply internal third-party devices to it or insert anything other than the listed interconnects or headphone adapters within this user manual.

If the Prima develops a fault or the casework becomes damaged, immediately disconnect from the mains power supply and connected equipment, and contact Chord Electronics for further advice.

With a thick, solid aluminium chassis, the Prima's casework largely protects the sensitive internal circuitry from radio frequency interference. However, for optimal performance, it is recommended that the following points are observed:



1. Consider placing the Prima away from wireless routers.



2. Separate the Prima from amplifiers using toroidal transformers.



3. Operate mobile phones at a distance to avoid interference.



Although the Prima is largely shielded, it can generate radio frequency interference that may have an effect on radio and television reception. If this occurs, please reconsider your placement.

Connecting your equipment 1.4

Before connecting the Prima to any equipment, consult the manufacturer's user guide to confirm compatibility.

When connecting the Prima to any equipment, make sure that all devices are off, including the Prima.

Once connected, switch all equipment on starting with the source and ending with the amplification.

Initially, operate the any connected equipment on its lowest gain setting and lowest volume setting, gently increasing to a comfortable listening level.

Never operate connected equipment to the Prima at excessive sound levels; permanent hearing damage and loss can occur.

The included 15V 4000mA power supply simply plugs into the Prima.

If the power supply is prematurely disconnected Prima may still remain active for up to 15 seconds, however, this may cause damage to connected equipment.



Never disconnect the power cable during operation. Only disconnect when Prima is off. If the power cable is disconnected during operation there is a risk of damage to connected equipment.



Warranty

2.0

- 2.1 Warranty period & registering your purchase
- 2.2 Making a claim & warranty exclusions

2.0 *Warranty*

Warranty period & registering your purchase

2.1

At point of sale, Chord Electronics Ltd. provides the Prima with a comprehensive five-year warranty* which covers defects in materials and workmanship through fair wear and tear. The warranty will be void if any other PSU other than that supplied is used.

*The warranty is transferable with proof of purchase, however is not available on ex-demonstration products.



Please use the form below to record the details of your purchase in the event that these are required at a later date, we further advise that all purchases are registered with Chord Electronics at: **chordelectronics.co.uk/register-product/**



| | |
|-------------------|--|
| RETAILER: | |
| PURCHASE PRICE: | |
| UNIT COLOUR: | |
| DATE OF PURCHASE: | |
| TRANSACTION ID: | |

Making a claim & warranty exclusions

2.2

In the unlikely event of a claim, you must provide Chord Electronics with the details of the claim, including your original proof of purchase and serial number in order to validate the nature of the repair.

Upon receipt, Chord Electronics will make an assessment within 30 days and provide a reasonable solution.

All warranty repairs must be carried out by Chord Electronics or an approved service centre to guarantee the quality and safety of the repair.

WARRANTY EXCLUSIONS: The warranty does not cover connected equipment, personal injury or development natural patina of the metalwork and will be null and void if the following is applied: wilful neglect; modification or tampering of the product; improper use of the product; acts of God; damage caused by a connected device; mechanical shock; fire or application of excessive heat or repair/modification by a non-authorised third-party vendor.

**Getting to know
Prima**

3.0

3.1 Getting to know Prima

3.2 The top panel

3.3 The rear panel

3.4 The remote control

3.0

Getting to know Prima

Getting to know Prima

3.1

Our Prima preamp forms part of the stylish and compact Choral range and has been designed to complement our Étude power amps. Despite its compact dimensions and space-saving footprint, the Prima is every bit a pedigree Chord amplifier.

With a ability to connect up to 5 inputs, Prima offers volume and balance control, giving you full autonomy over your system. Prima also has a recording output deisgned for tape.

To get the very most from the device we recommend that you familiarise yourself with the user manual.



The top panel

3.2

Prima gives you a complete control with a remote control (page 15) but you also have a button for main line selection and tape line selection. On the front there is also a dial for both Volume and balance.

There is also a display screen and viewing window.

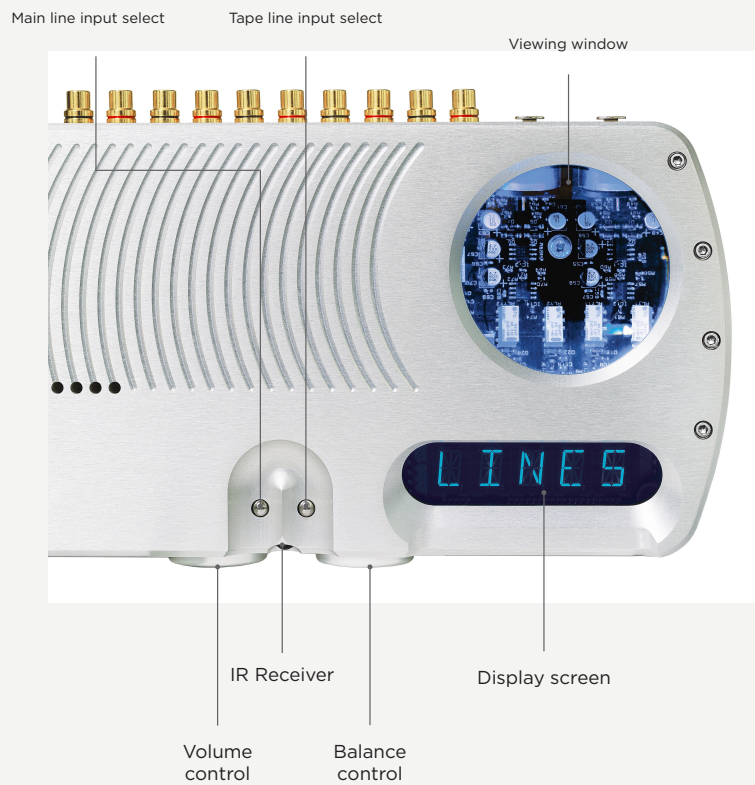

The rear panel

3.3

The rear panel houses the device's wide-ranging connectivity, inputs and outputs. The Prima has several inputs and output allowing for high flexibility. Multiple inputs can be used all at the same time.

When installing any cable, you must make sure that they securely click into place.

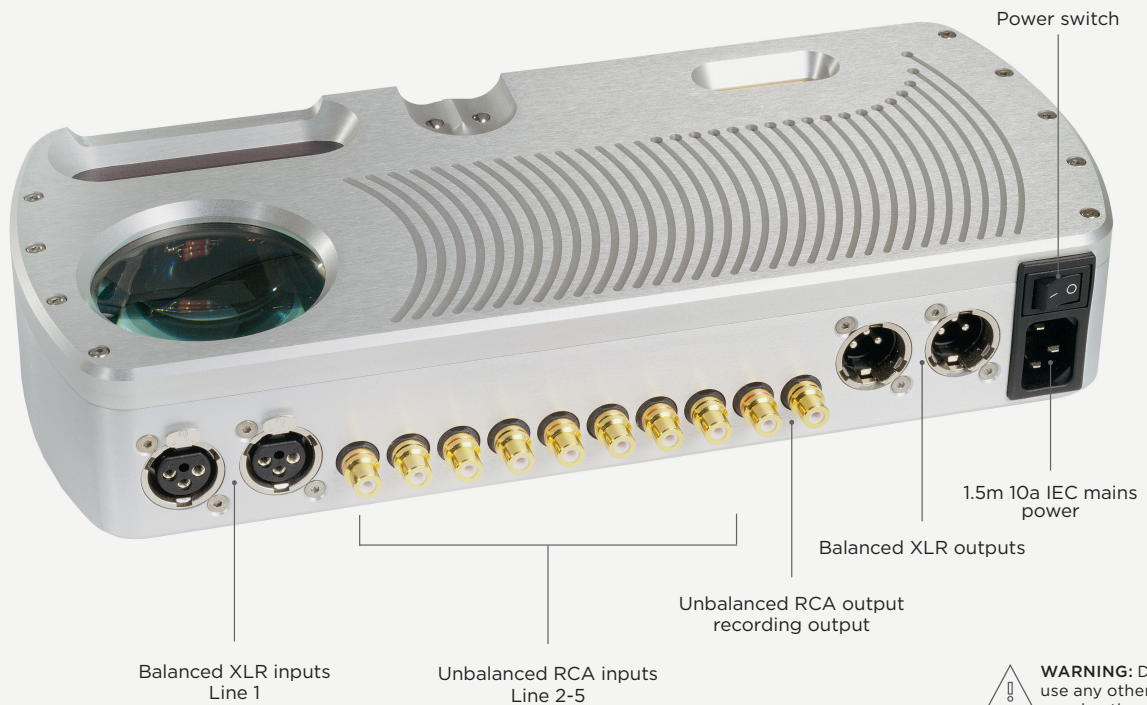

The remote control

3.4

The remote control gives you control over your full set up. The top section is reserved for Blu MKII and Dave while the bottom section is used for Prima.

Your selection on the remote will show on the Prima display screen. As the infra-red remote control requires a direct line of sight to the viewing portal, please avoid placing objects in front of either device.

NOTE: The volume buttons will only work with Prima. To change inputs when DAVE is also in the system use the side buttons to change settings. Please see DAVE manual on using the remote control.

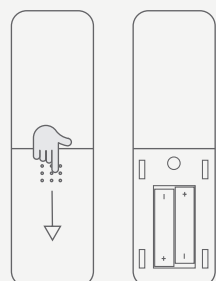
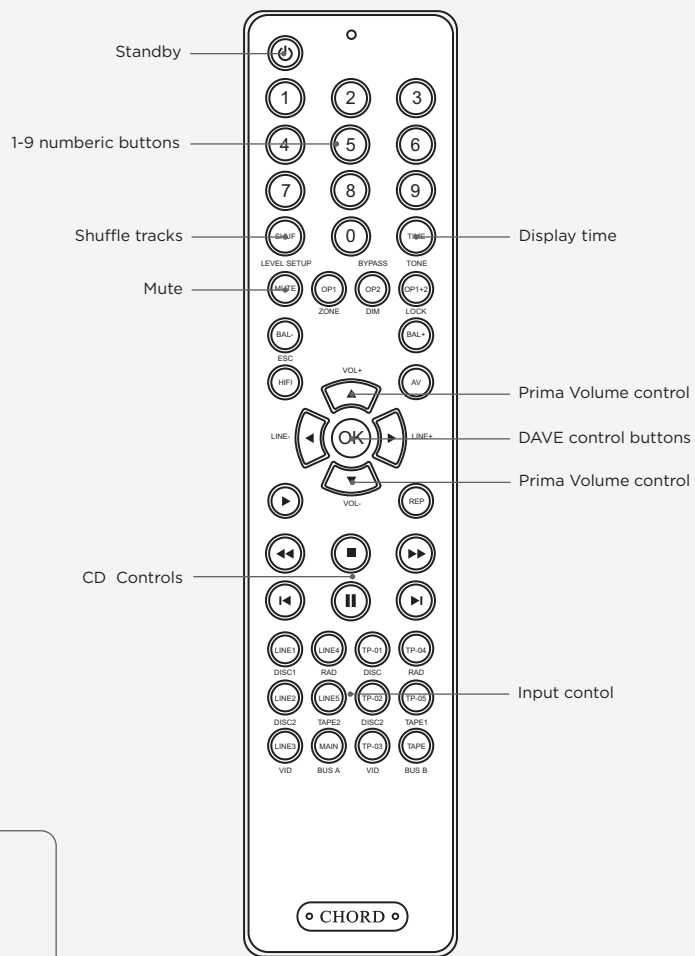

NOTE: Please only insert AAA batteries into the IR remote control and observe the correct orientation as indicated within the remote control. Failure to do so could result in non-operation or battery leakage.

Setting up Prima

4.0

- 4.1 Placement
- 4.2 Connecting an input to Prima
- 4.3 Connecting Prima to a Power amplifier
- 4.4 Connecting Prima to a recording device

4.0 *Setting up Prima*

Placement

4.1

Whilst the Prima operates normally within a stack of Chord Electronics Emsable stands along with units such as the DAVE and Etude, it is recommended that you allow the device to breathe. Allocating 10cm of space around it to convection-cool during operation is advised. If possible, do not place the unit(s) inside a cabinet.



As the infra-red remote control requires a direct line of sight to the viewing portal, please avoid placing objects in front of either device.



Connecting an input to Prima 4.2

In order to connect up Prima to a source, you must connect your cables to one of the inputs listed below. Prima can have up to 5 inputs at once so it gives you the flexibility to fully curate your system with minimal effort required.

First, you must ensure that Prima, and any connecting equipment, is turned off.

For a balanced input use the double XLR inputs listed below.
For unbalanced inputs use the other 4 inputs listed below.

Please note that each input is arranged as a stereo pair, right and then left. Later, when you come to switch Prima on, each pair of inputs will be shown as 'LINE X' on the display. LINE 1 begins with the pair of XLRs, LINE 2 is the RCA pair next to these and so on.

It should be carefully noted that the two XLR connectors next to the mains IEC input, as well as the two RCA plugs directly next to them, are outputs. You must not connect any inputs here.

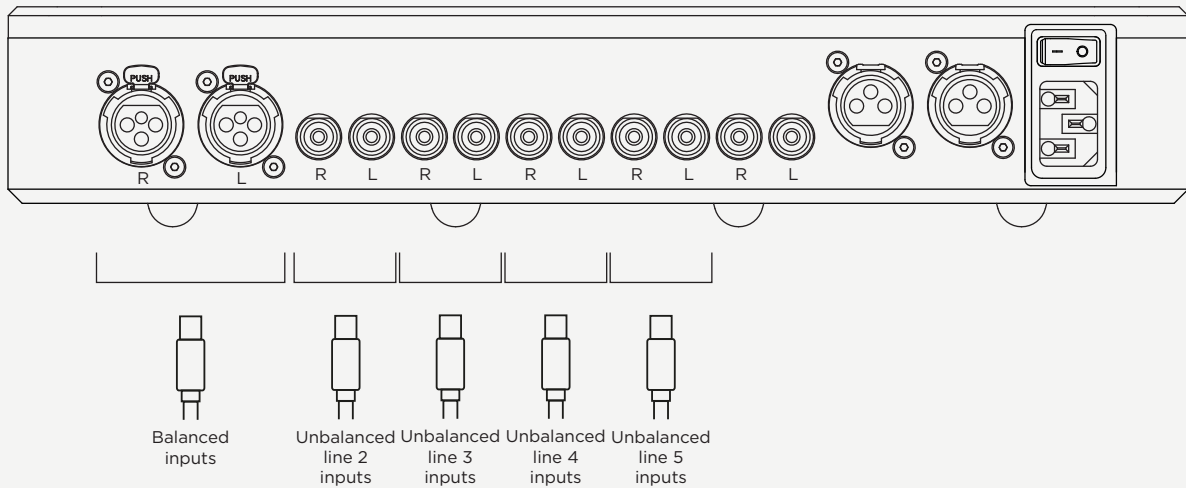

Connecting Prima to a Power amplifier 4.3

Using The XLR outputs shown below, it is simple to connect the Prima to a power amplifier such as Étude:

- 1) Turn off the Prima and any other connected equipment.
- 2) Locate the XLR Outputs on the Prima and connect to the XLR input on the chosen power amplifier.
- 3) Turn on all equipment, including the Prima the power amplifier.
- 4) Allow both the Prima and power amplifier to power up.
- 5) Initiate playback.

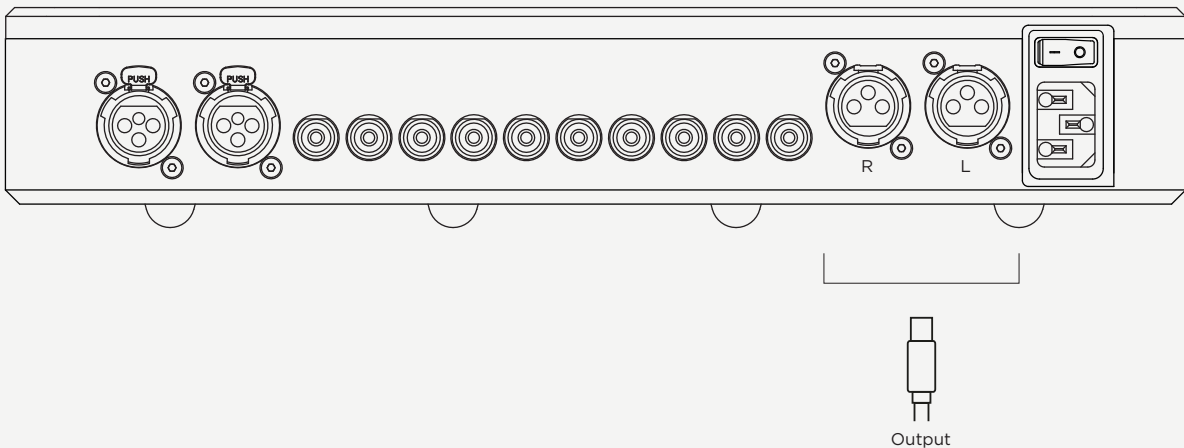

Connecting Prima to a recording device

4.4

Prima comes equipped with recording outputs. These are the two RCA connectors next the output XLRs. These RCA outputs are always live, at line level, and cannot be attenuated. Never connect an amplifier to these connectors! You can select the input to be passed through to the recording output via the dedicated button on the front of the device.

- 1) Turn off the Prima and any other connected equipment.
- 2) Locate the RCA inputs shown below and connect your recording device with RCA cables.
- 3) Turn on all equipment including the Prima.
- 4) Select the appropriate input on the recording device.
- 5) Initiate music playback and recording.

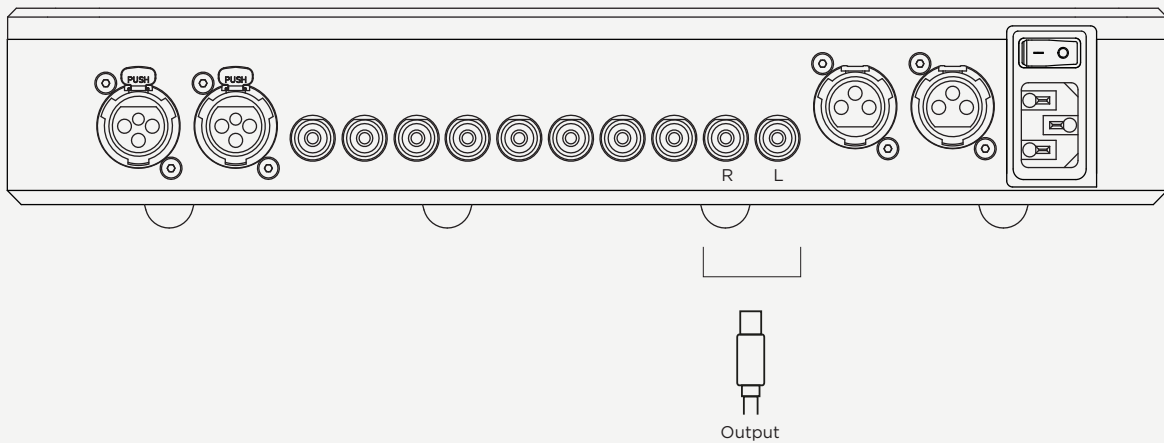

How to navigate the menu

5.0

- 5.1 Basic navigation
- 5.2 Volume and balance control
- 5.3 Display
- 5.4 Viewing settings

5.0

How to navigate the menu

Basic navigation

5.1

With Prima powered on you will need to select your input. do this by using the left button to select the pair of inputs to be played. The right button will select the pair of inputs to be sent only to the recording output.

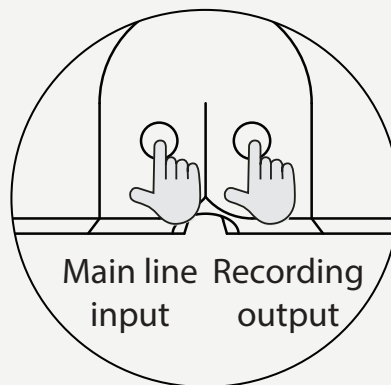

Volume and balance control 5.2

On your source commence playback and, using the left-hand dial, slowly increase the volume of Prima, to a safe listening level.

The volume range runs from 0 to 98 and is displayed on the PRIMA as you alter the volume. If the outputs are muted, a volume change will un-mute the outputs to prevent large changes in volume from damaging your loudspeakers

The dial on the right adjusts balance. Typically, this should remain in the centre of its rotation for balanced sound between the left and right outputs.

Use the balance dial to shift the balance between the left and right loudspeaker. A clockwise turn of the knob will shift the balance to the right speaker and an anti-clockwise turn of the knob will shift the balance to the left speaker.

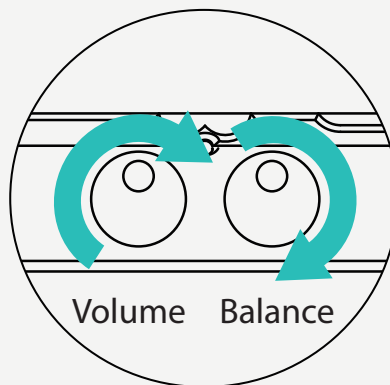

Display

5.3

Main line output: To assign the main output with a particular input signal, press the Main line button several times to cycle through the 5 line inputs until, the display shows the input you wish to use. The options are shown in the diagram below;

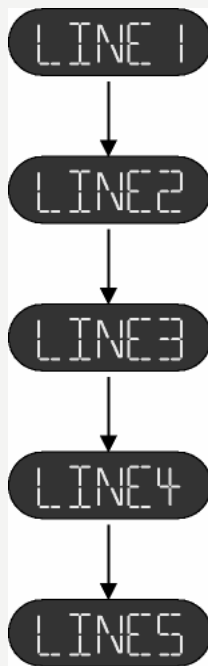

Recording line output: To assign a recording output with a particular input signal, press the recording line button several times to cycle through the 5 line inputs until, the one you wish to use is displayed. The options are shown in the diagram below

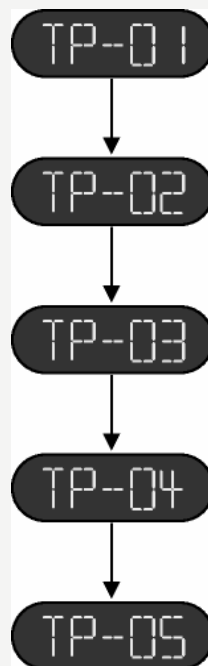

Volume: Use the volume knob to adjust the volume manually. A clockwise turn of the knob will increase the volume and an anti-clockwise turn of the knob will decrease the volume. The volume range runs from 0 to 98 and is displayed on the PRIMA as you alter the volume. If the outputs are muted, a volume change will un-mute the outputs to prevent large changes in volume from damaging your loudspeakers. An example is display below;

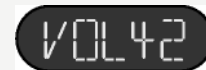

Viewing settings

5.4

Main line output: To view the settings for the main line press and hold the main line button for two seconds. The first information that is shown is the current gain setting for the input line that is assigned to the main line output. The PRIMA stores the gain setting for each input line. After the gain setting has been shown for a second, the input line that is currently assigned to the main line is displayed.

Recording line output: To view the settings for the recording line press and hold the recording line button for two seconds. The immediate information that is shown is the current gain setting for the input line that is assigned to the tape line output. The PRIMA stores the gain setting for each input line. After the gain setting has been shown for a second, the input line that is currently assigned to the recording line is displayed. When you are viewing the recording line settings, the display will indicate this by showing 'TP'. The number of the input line that is assigned to the tape line is also shown.

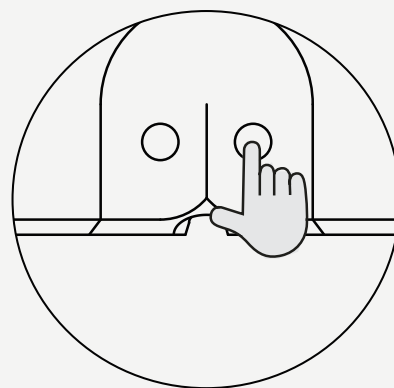
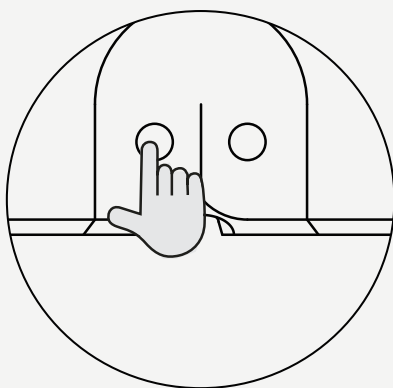

Special features

6.0

6.1 Gain

6.0 *Special features*

Gain

6.1

You can adjust the input gain on your input devices so that you can align the volume levels of your different inputs. There are six settings, which are x0.25, x0.50, x0.75, x1.00, x1.25 and x1.50.

Most modern input devices such as CD players have an unbalanced output voltage of 2V and a balanced output 4V, which does not require any increased gain amplification.

However, older audio equipment may have an output voltage of less than 2V, in which case you may like to adjust the input gain.

Gain on main line inputs: Press Main on the pre amp remote followed by the VOL + button to increase the gain rate or VOL - to decrease.

Gain on recording line inputs: Press Tape on the pre amp remote followed by the VOL + button to increase the gain rate or VOL - to decrease.

Gain display: Once you have adjusted the gain setting on an input device your amplifier will remember the setting on booting up the system in the future. The six available gain settings are shown below as they are displayed on the Prima.





Chord Electronics Ltd.

